

1.0 LP2953A LOW DROPOUT REGULATOR

1.1 Scope

The purpose of this analysis is to model the National Semiconductor LP2953A low dropout voltage regulator.

Analysis:	Regulator modeling
Performed by:	
Last Rev Date:	5/10/2002
Publication Number:	Nat'l LP2953A Data sheet
Revision:	May 1999
SPICE File	LP2953A.CIR

1.2 Functional Description

The LP2953A is a low power low dropout voltage regulator with current limiting and undervoltage lockout. A shutdown input disables the regulator and discharges the output through an internal crowbar. If the output drops out of regulation, an externally available error flag goes low. An auxiliary comparator with one input tied to V ref is also provided.

1.3 Assumptions and Comments

1. Frequency response and phase margin are modeled to agree with the customer's test data. The manufacturer's data sheet does not provide this information.
2. For higher frequencies, the model's frequency response does not agree with the customer's test data. The customer's data is believed to be in error. In particular, above a few hundred kHz, the gain of the regulator is actually lower than that of the test circuit's 10 ohm resistor / load capacitor, so at higher frequencies, the customer's bode plot is a plot of the test circuit, not of the regulator. This is the cause of the 180 degree phase reversal at ~400kHz. The test circuit spice model also exhibits this behavior but at a higher frequency. Note that the regulator's actual performance is more stable than the customer's data would suggest.
3. Gain margin is not modeled.
4. In order to agree with the customer's data for frequency response, output impedance could only be approximately modeled.
5. Current limiting is modeled, but the foldback characteristics of mfr's fig. 44 are not modeled.
6. Hysteresis is not modeled for any of the comparator inputs.
7. The inversion of the error output during shutdown ($V_{in} \leq 1.3V$) is not modeled.
8. Load transient response is approximately modeled.
9. Quiescent and ground current are approximately modeled to agree with mfr's fig. 27 and 30.

1.4 SPICE Simulations and Analyses

The model was simulated and the results were compared to data supplied by the customer as well as the manufacturer’s data sheet. The Spice simulation results are shown below.

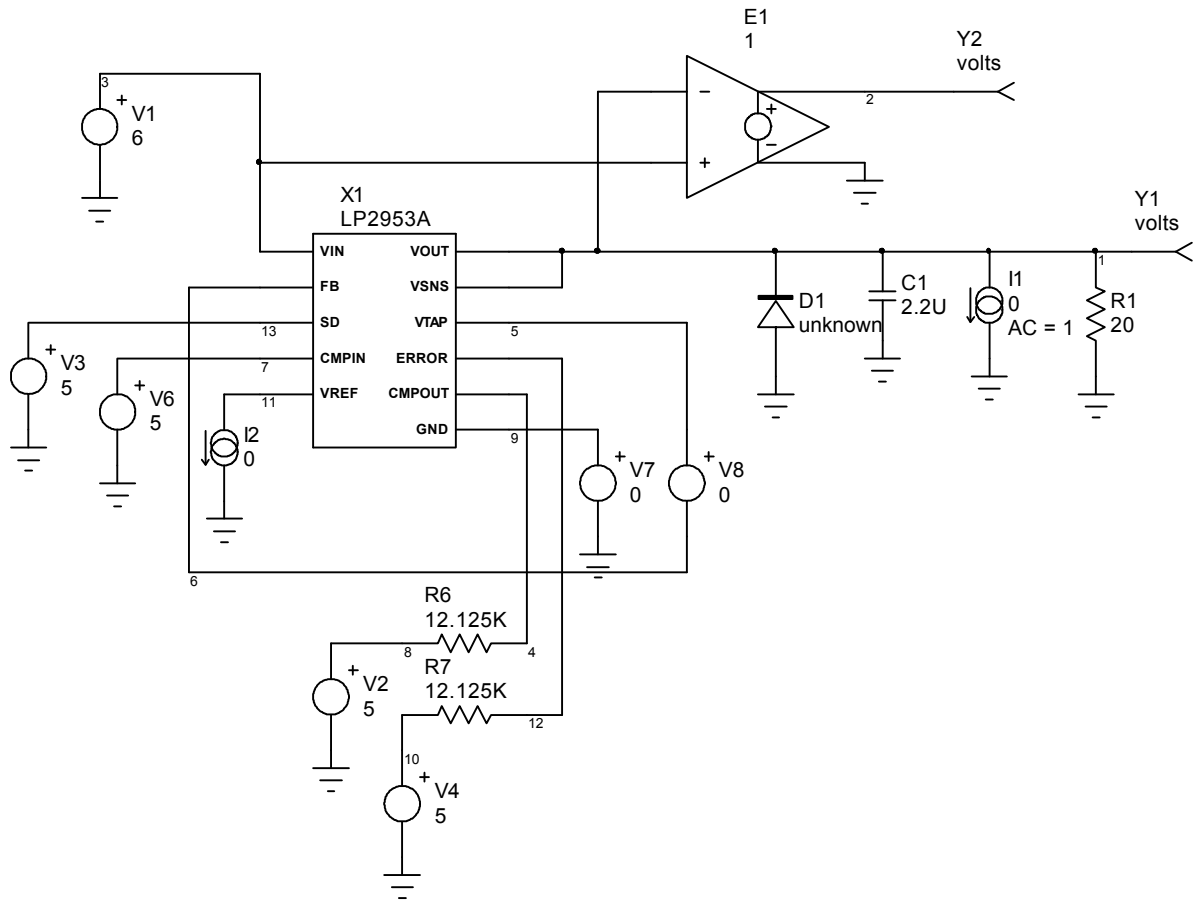

SPICE test circuit for manufacturer’s test conditions

Output Impedance

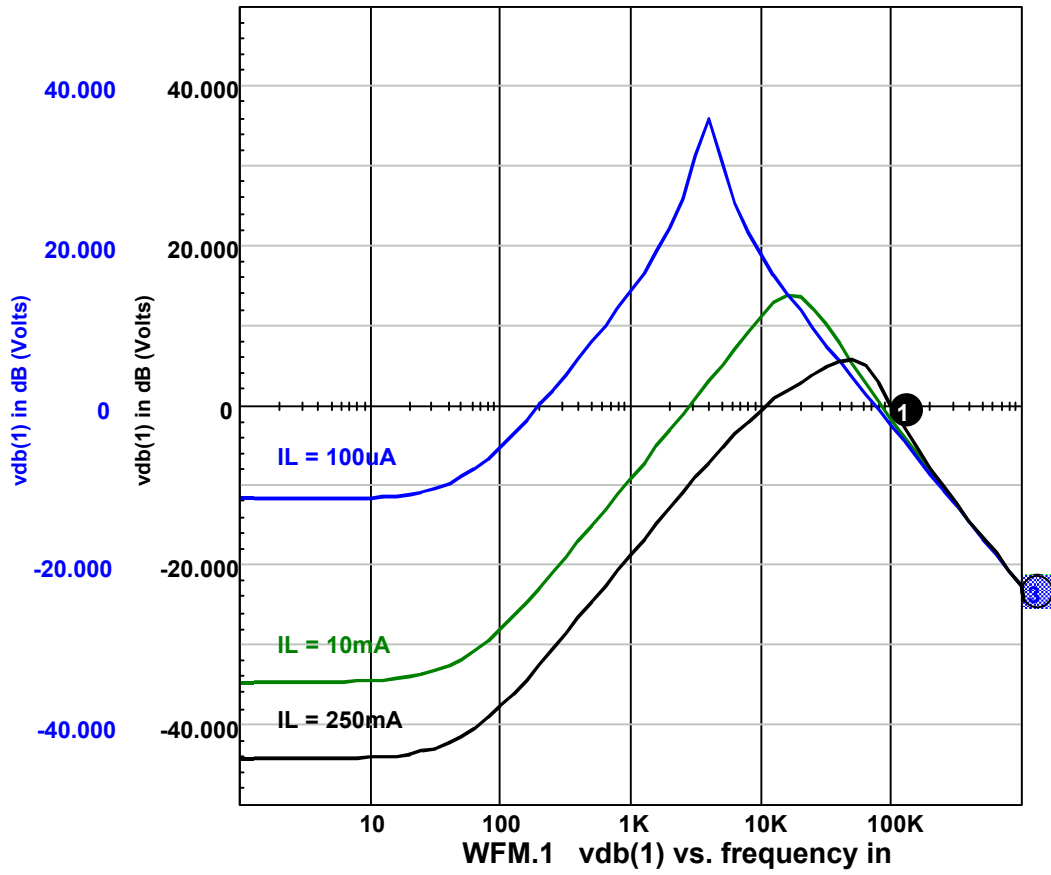

SPICE Waveforms of output impedance

Line transient response

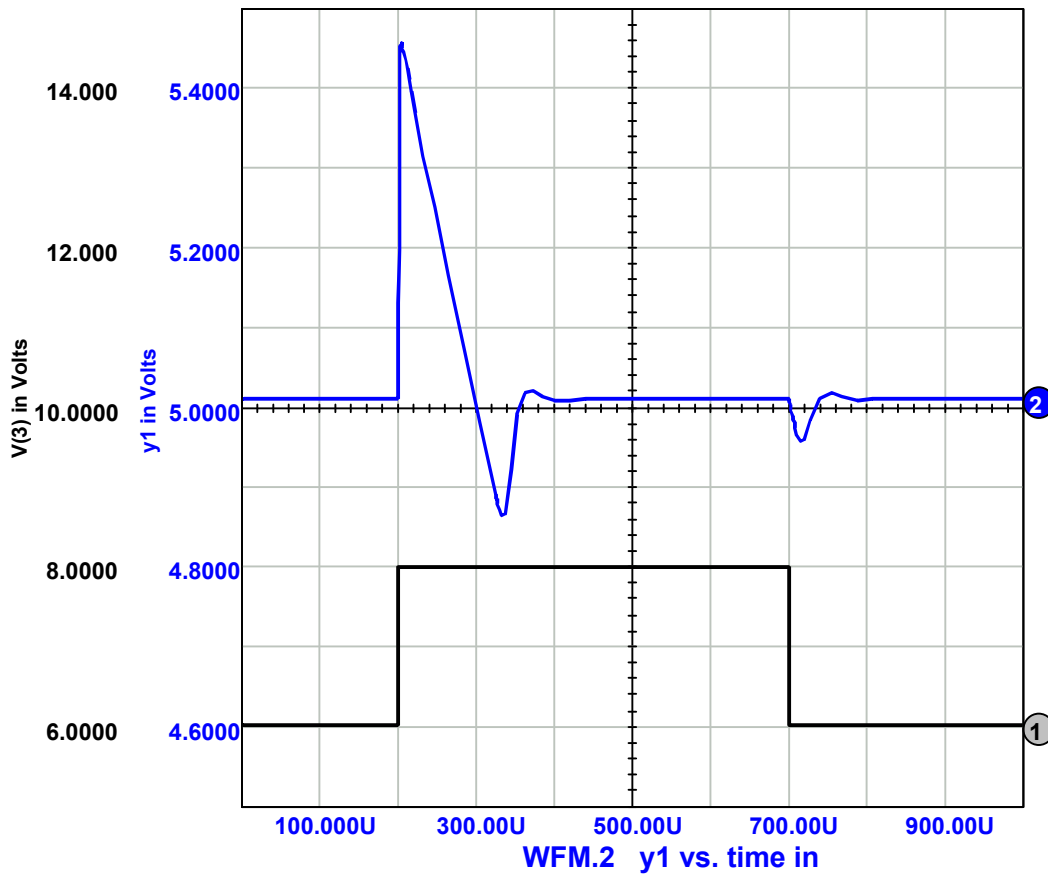

SPICE Waveforms of line transient response

IL = 10mA

Load transient response

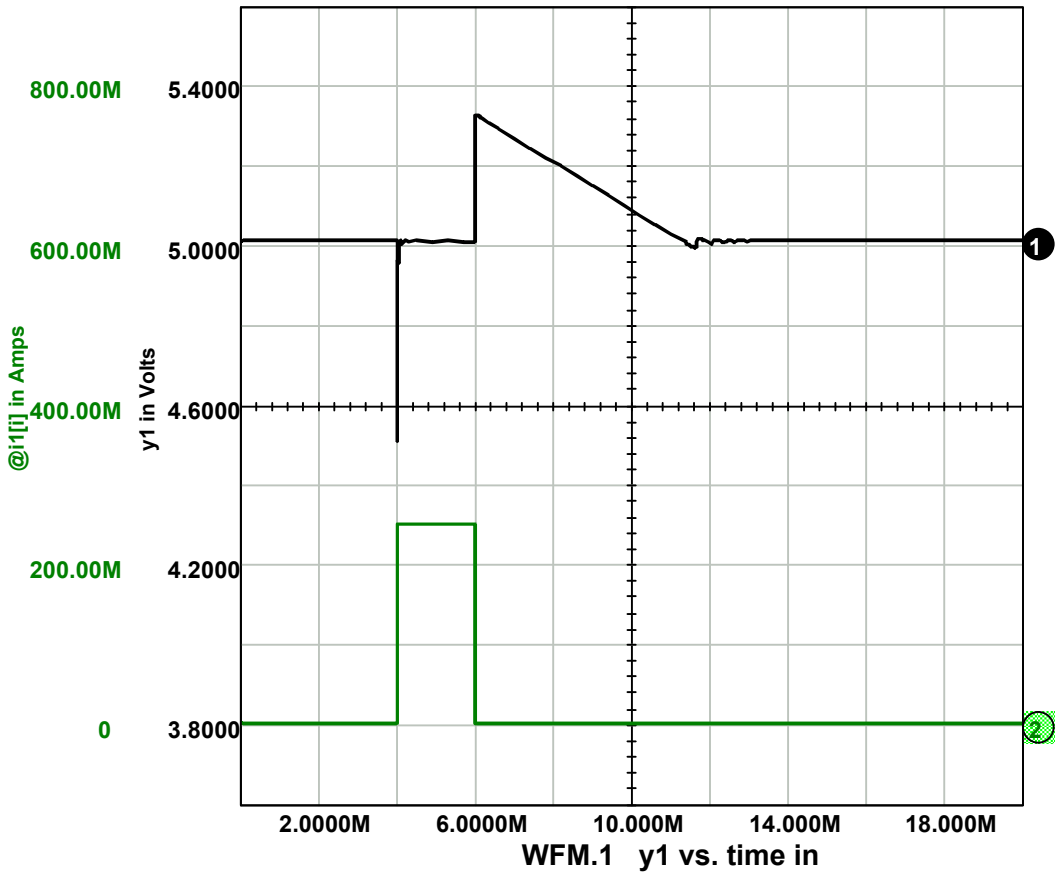

SPICE Waveforms of load transient response

Dropout characteristics

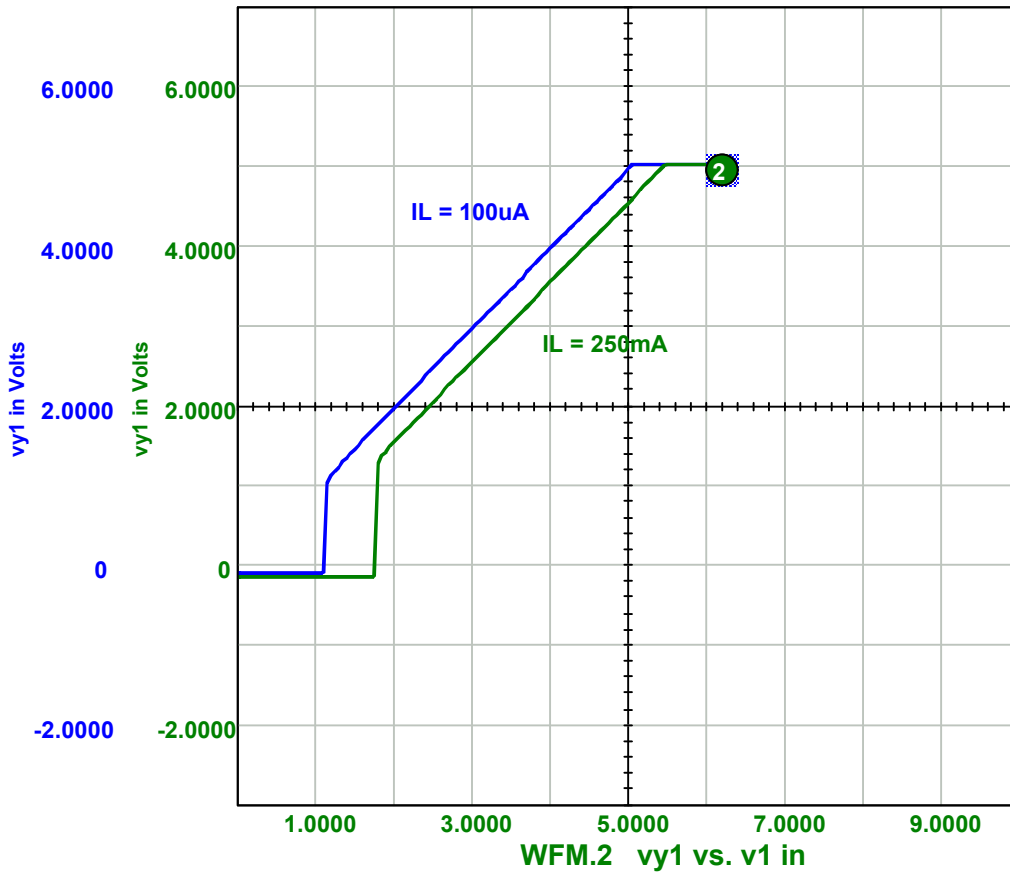

SPICE Waveforms of dropout characteristics

Quiescent current

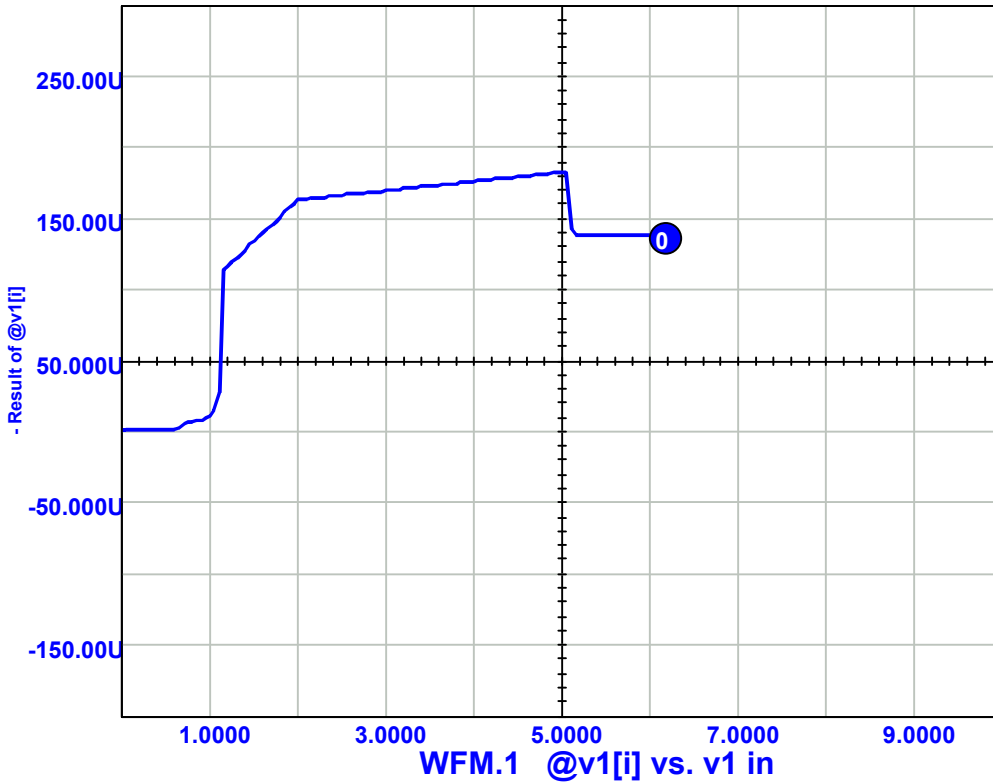

SPICE Waveform of quiescent current

IL = 100uA

Ground pin current

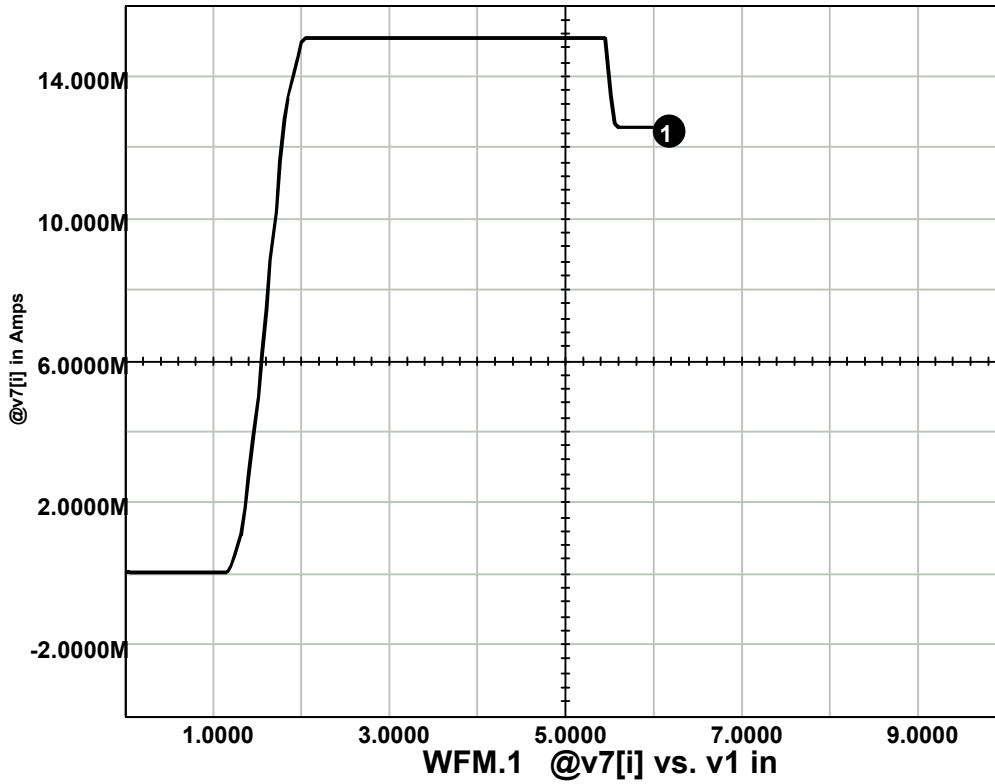

SPICE Waveform of ground pin current

IL = 250mA (R6 and R7 deleted from test circuit)

Enable transient

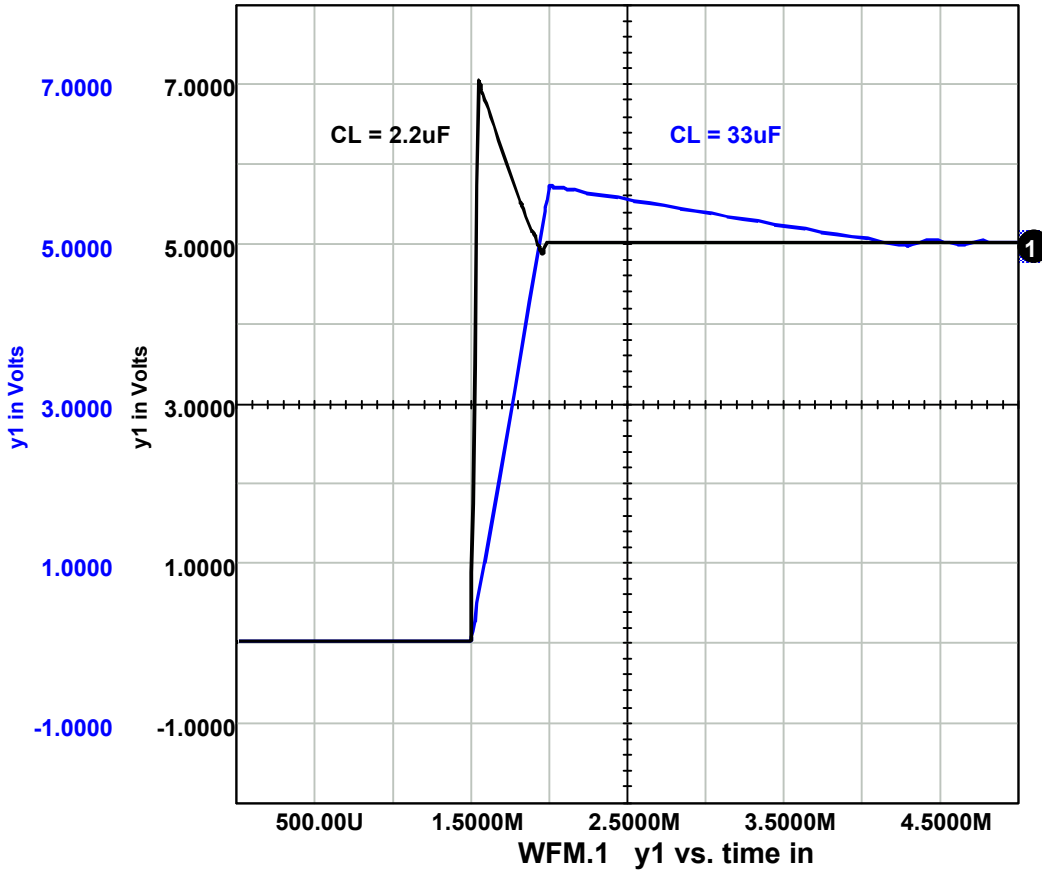

SPICE Waveforms of enable transient

IL = 10mA, V IN = 14V

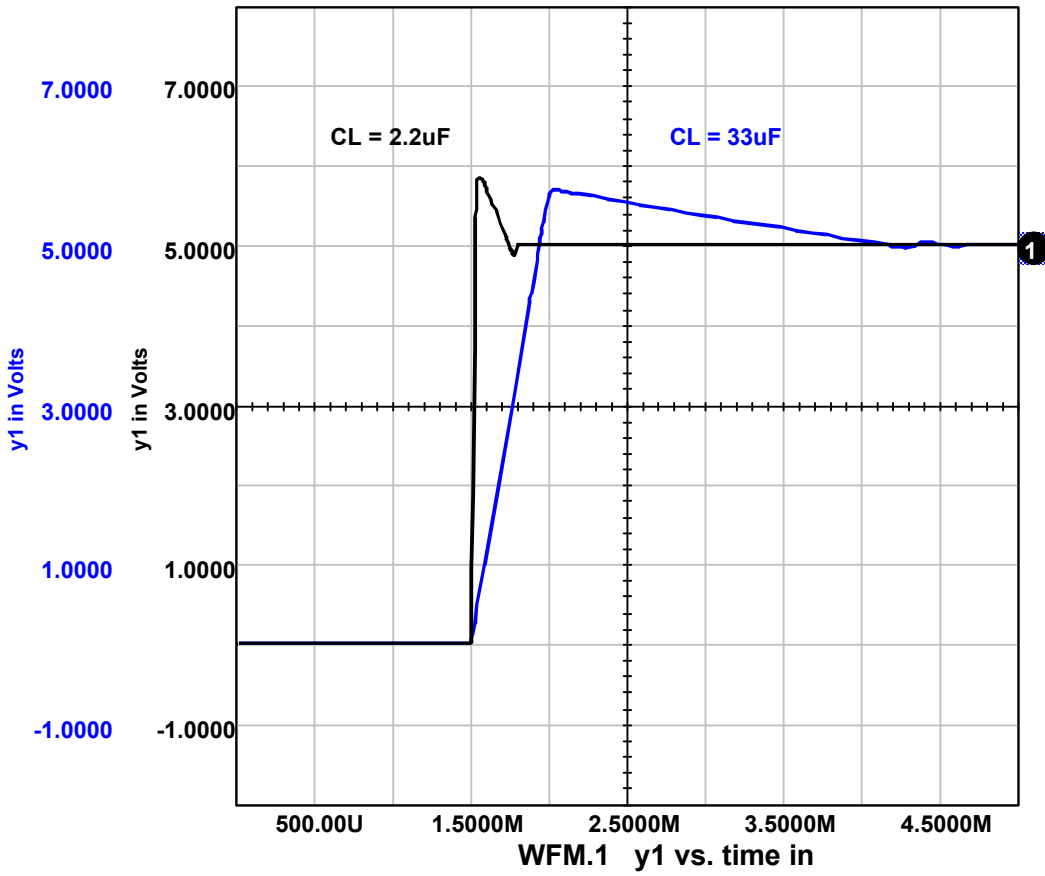

SPICE Waveforms of enable transient

IL = 10mA

5.4.6 Conclusions and Recommendations

The Spice simulation results are summarized below in table 1 and are within the manufacturer's electrical specifications. Frequency response agrees with data supplied by the customer except as noted above.

Table 5.4.1 LP2953A SPICE Model - Summary of Simulation Results

Parameter	Typ Spec	SPICE	UNITS
REGULATOR			
Output voltage, customer's test circuit	2.758	2.756 V	
mfr's test conditions	5.00	5.01 V	
Output voltage load regulation, IL = 1 to 250mA	0.04	0.042 %	
IL = 0.1 to 1mA	0.04	0.002 %	
Output voltage line regulation, V in = 6 to 30V	0.03	0.03 %	
Phase Margin, customer's test circuit, IL = 80mA	78.56	78.55 degrees	
at	27.9	25.7 kHz	
IL = 50mA	75.26	76.32 degrees	
at	22.7	22.5 kHz	
IL = 1mA	42.26	48.64 Degrees	
at	3.8	4.5 kHz	
Dropout Voltage, IL = 1mA	60	90 mV	
IL = 50mA	240	236 mV	
IL = 100mA	310	298 mV	
IL = 250mA	470	465 mV	
Current limit, R out = 1 mOhm	380	384 mA	
Reference voltage	1.23	1.23 V	
Reference voltage line regulation, V in = 6 to 30V	0.03	0.03 %	
V in = 2.5 to 6V	0.03	0.0044 %	
Reference voltage load regulation, IL = 0 to 200uA	0.25	0.25 %	
Feedback pin bias current	20	20 nA	
Output off pulldown current	50	49.9 mA	
DROPOUT DETECTION COMPARATOR			
Output "HIGH" leakage	0.01	0.01 uA	
Output "LOW voltage	150	149 mV	
Upper threshold voltage	60	60 mV	
Lower threshold voltage	85	60 mV	

Table 5.4.1 Summary of Simulation Results (cont.)

Parameter	Typ Spec	SPICE	UNITS
SHUTDOWN INPUT			
Input offset voltage	3	3 mV	
Input bias current	10	10 nA	
AUXILIARY COMPARATOR			
Input offset voltage	3	3 mV	
Input bias current	10	10 nA	
Output "HIGH" leakage	0.01	0.01 uA	
Output "LOW voltage	150	149 mV	